

Article number: 03215008

Description: Fluro Rod End GILRS 8-R

Housing and ball in stainless steel with left-handed thread

Measures

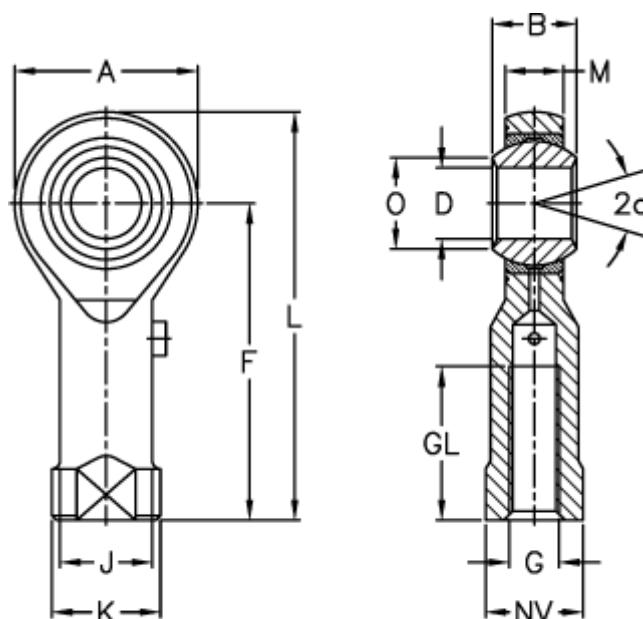

Str. 3 uden smørenippel

A	= 24	J	= 12.5	Weight (g) = 46
a (degrees)	= 14	K	= 16	
B	= 12	L	= 48	
D	= 8	M	= 9	
Dynamic load C (kN)	= 7.1	NV	= 13	
F	= 36	O	= 10.4	
G	= M8	Permissible rpm	= 1200	
GL	= 16	Static load C0 (kN)	= 20.7	